

ercol

teramo 2683 5 drawer wide chest

Thank you for purchasing this teramo chest. Please read the instructions carefully before use to ensure safe and satisfactory operation of this product.



This item is **HEAVY**



Necessary Tools



Pre-assembly preparation

Please ensure instructions are read in full before attempting to assemble this product

Please check the pack contents before attempting to assemble this product. A full checklist of components is given in this leaflet. If any components are missing, please contact the retailer from whom you bought this product.

This product is **HEAVY**, it should be assembled as near as possible to the point of use. **TAKE CARE WHEN LIFTING** to avoid personal injury and (or) damage to the product.

This product takes approximately **20 MINUTES** to assemble with **2 PEOPLE**.

The fittings pack contains **SMALL ITEMS** which should be **KEPT AWAY FROM YOUNG CHILDREN**.

Ref: 00237/2683

Wall fixing instructions

Thank you for purchasing this ercol product.

Please read the instructions carefully before use to ensure safe and satisfactory operation of this product.

Installation shall be carried out exactly according to the manufacturer's instructions, otherwise a safety risk can occur if incorrectly installed.

WARNING: In order to prevent overturning this product must be used with the wall attachment device provided.

Remove two top drawers by press up the stopping pins as shown.

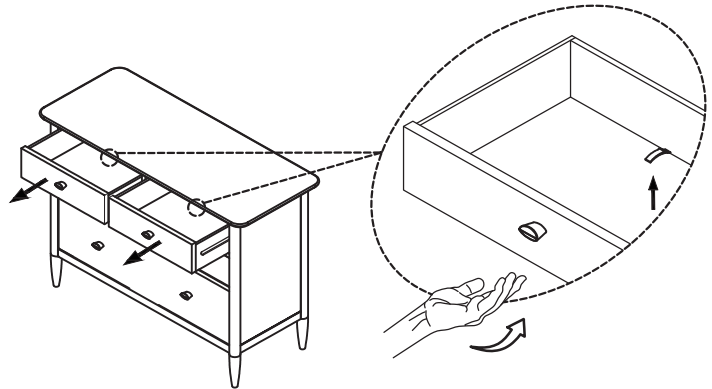

1. Place your product in the final position. Loosen the screws on the metal brackets just enough so that the slotted bracket can be extended to meet the wall.

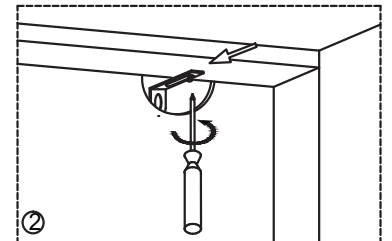
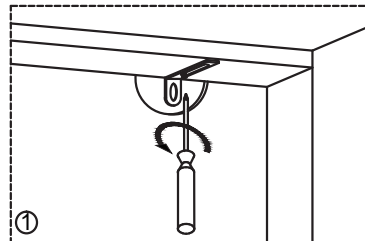

2. Then re-secure the screws.

3. Mark the wall for drilling through the hole in the short face of the bracket.

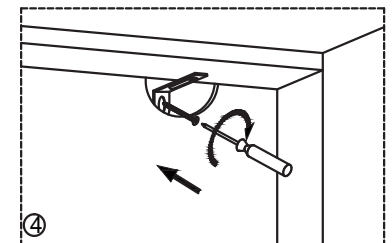
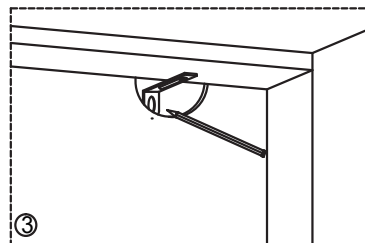

Then remove the unit from the wall so that the marked holes can be drilled.

Ensure you use an appropriate fixing type for your wall (see page 3). Then return the unit to position.

4. Secure the unit to the wall fixings with own screws through the brackets.

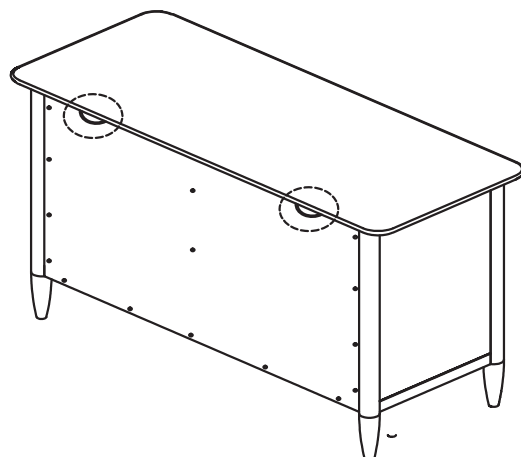

Warning

Serious or fatal crushing injuries can occur from furniture tipping over.

To prevent this furniture tipping over it must be permanently fixed to the wall.

Wall attached item only.
A guide to wall mounting and fixings

Warning

Serious or fatal crushing injuries can occur from furniture tipping over.
To prevent this furniture from tipping over it must be permanently fixed to the wall.

Wall fixing screws are not included, since different wall materials require different types of screws / fixings.
Please ensure you use the correct screws / fixings for your type of walls and seek professional advice if you are not sure.

Failure of the product due to incorrect fixings is the responsibility of the installer.

Important: When drilling into the walls always check that there are no hidden wires or pipes etc.

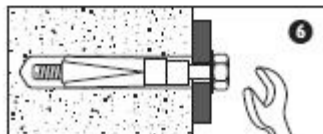
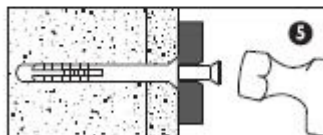
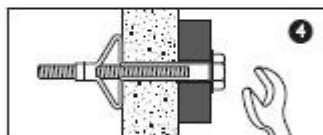
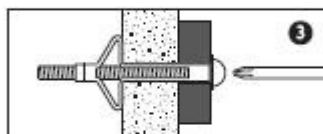
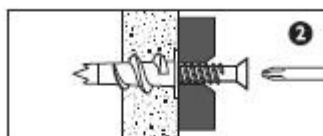
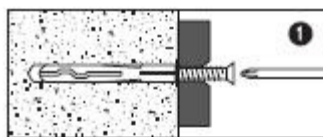

Types of walls

You can use one of the following types of wall plug if your walls are made of brick, breezeblock, concrete, stone or wood.

1. General Purpose wall plug

Generally aerated blocks should not be used to support heavy loads, use a specialist fitting in this case. For light loads, general - purpose wall plugs can be used.

2. Plasterboard wall plug

For use when attaching light loads on to plasterboard partitions.

3. Cavity Fixing wall plug

For use with plasterboard partitions or hollow wooden doors.

4. Cavity Fixing - Heavy Duty wall plug

For use when fitting or supporting heavy loads such as shelving, wall cabinets and coat racks.

5. Hammer Fixing wall plug

For use with walls stuck with plasterboard. The hammer fixing allows it to be fixed to the wall rather than the plasterboard. Always check the fixing is secure to the retaining wall.

6. Shield Anchor wall plug - Heavy loads

For use with heavier loads such as TV and Hi-Fi speakers and satellite dishes etc.

Safety: Periodically check all fittings and wall fixings to ensure they have not come loose and retighten as necessary.

If the chest is not level on your floor use the wedges provided, and snap them off so that they do not protrude out from the cabinet's legs, you can also snap them lengthways if desired.

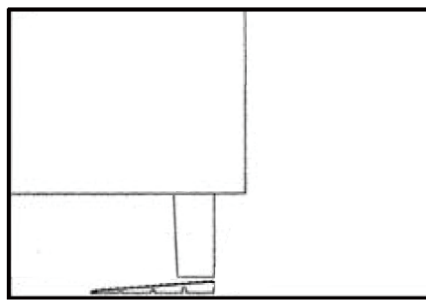
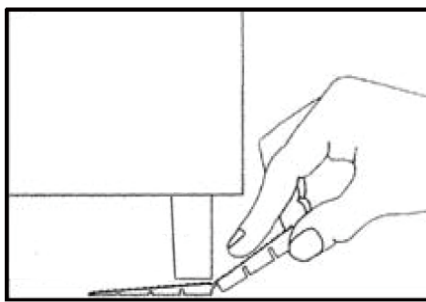
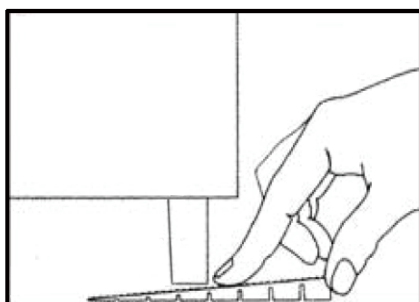

PLEASE KEEP THESE INSTRUCTIONS FOR FUTURE REFERENCE

Ercol Furniture Ltd, Summerleys Road, Princes Risborough, Buckinghamshire. HP27 9PX www.ercol.com